

40

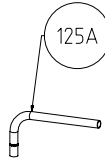

125A

1074

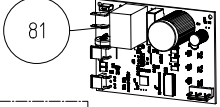

81

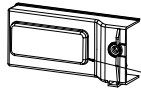

533

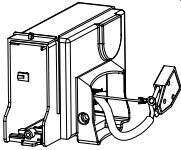

2111



2111



38

205

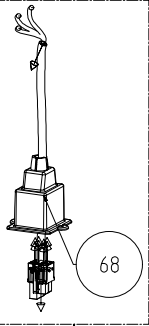

68

361

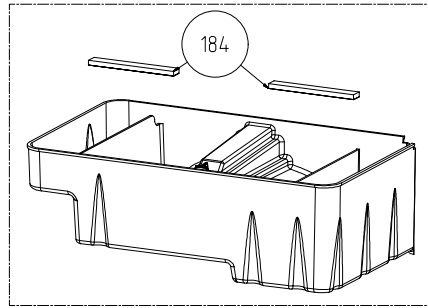

184

132

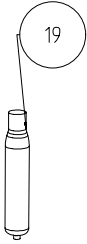

19

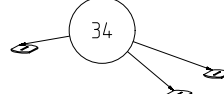

34

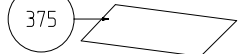

375

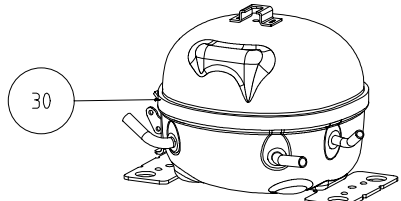

30

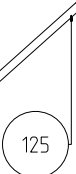

125

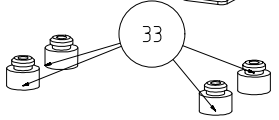

33

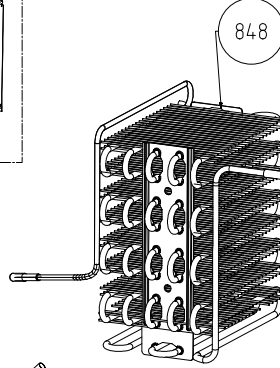

848

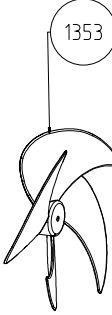

1353

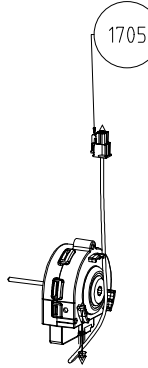

1705

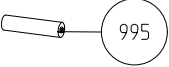

995

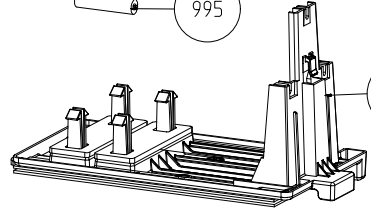

55

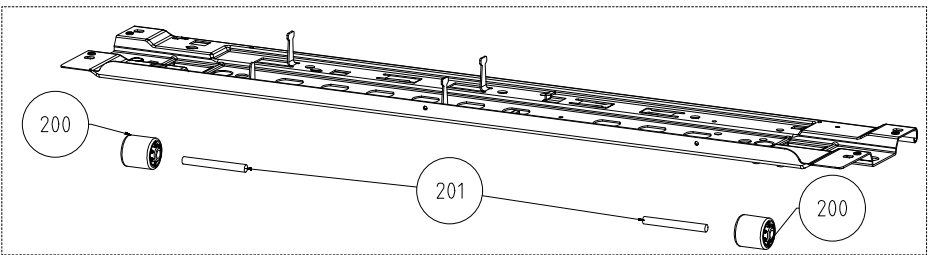

200

201

200

202

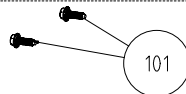

101

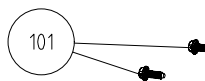

101